

**NSQ CURRENT TRANSFORMERS****NSQ SERIES**

Primary current: 30A-3000A  
 Secondary current: 5A, 10A  
 Standard approval: BS7626, IEC44-1  
 Maximum voltage: 0.66KV  
 Frequency: 50-60Hz  
 Rated load: 2.5VA, 15VA  
 Class: 0.5, 1.0, 3.0  
 Short-time thermal current:  $I_{th}=60 \times I_h$   
 Rated security efficient:  $F_s < 5$

**TECHNICAL DATA:**

Model	Primary/Secondary	Busbar Hole Dimension	Rated Burden (VA)	Class	Rated Voltage	Rated Frequency
NSQ-30	30/5A-300/5A	30×10mm	2.5-5	0.5/1.0	0.72	50/60Hz
NSQ-35	50/5A-400/5A	35×10mm	5	0.5/1.0	0.72	50/60Hz
NSQ-40	100/5A-600/5A	40×10mm	10	0.5/1.0	0.72	50/60Hz
NSQ-60	600/5A-1600/5A	60×10mm	15	0.5/1.0	0.72	50/60Hz
NSQ-100	800/5A-3000/5A	100×10mm	15	0.5/1.0	0.72	50/60Hz

**DIMENSION OF CASE[MM]:**

Model	A	B	C	D	E	F
NSQ-30	30	78	46	95	112	70
NSQ-35	40	70	46	84	100	70
NSQ-40	45	80	46	87	104	70
NSQ-60	60	110	53	130	148	80
NSQ-100	100	155	53	174	191	80

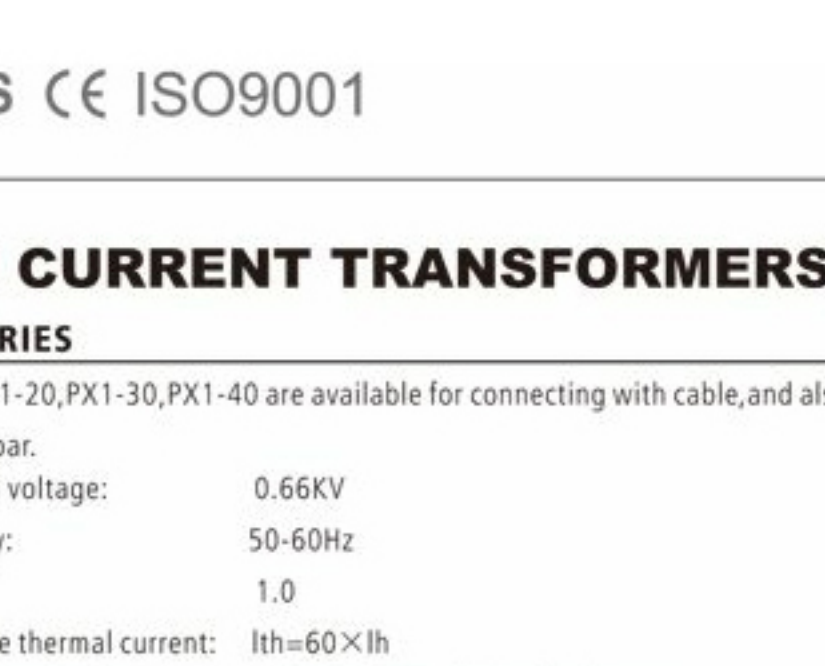
**OUTLINE DRAWING:****PX1 CURRENT TRANSFORMERS****PX1 SERIES**

Model PX1-20, PX1-30, PX1-40 are available for connecting with cable, and also available for connecting with bus bar.

Maximum voltage: 0.66KV  
 Frequency: 50-60Hz  
 Class: 1.0  
 Short-time thermal current:  $I_{th}=60 \times I_h$   
 Mounting methods: either by din rail(35mm) or by screws  
 diameter 22mm(PX1-20, PX1-20L)  
 Window dimensions:  $31 \times 10$ mm(PX1-30, PX130L)  
 $41 \times 10$ mm(PX1-40)

**TECHNICAL DATA & SPECIFICATION:**

Model	Primary/Secondary	Busbar Hole Dimension (MM)	Rated Burden (VA)	Class	Rated Voltage
PX1-20	50/5A-150/5A	$\Phi=20$ mm	1.5-2.5	1.0	660V
PX1-30	100/5A-500/5A	30×10mm	1.5-2.5	1.0	660V
PX1-40	150/5A-1000/5A	40×10mm	3-10	1.0	660V
PX1-20L	50/5A-150/5A	$\Phi=20$ mm	1.5-2.5	1.0	660V
PX1-30L	100/5A-500/5A	30×10mm	1.5-5	1.0	660V

**DIMENSION OF CASE[MM]:**

Model	A	B	C	D	E
PX1-20	53	28	57	66	54
PX1-30	53	28	57	66	54
PX1-40	71	45	73	81	65
PX1-20L	53	28	57	66	54
PX1-30L	53	28	57	66	54

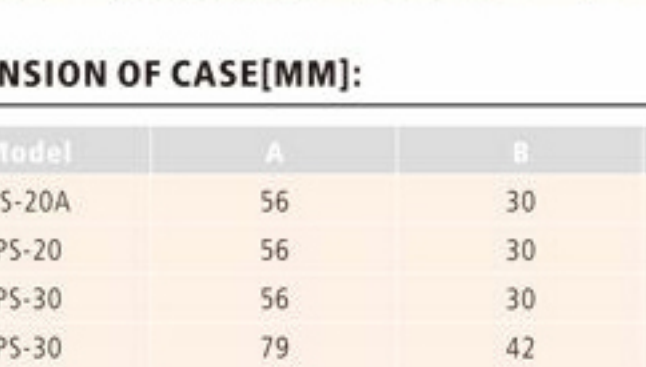
**OUTLINE DRAWING:**

Switch on to the future

**PS CURRENT TRANSFORMERS****TECHNICAL DATA & SPECIFICATION:**

Model	Rated Current (A) Primary/Secondary	Busbar Hole Dimension	Rated Burden (VA)	Accuracy Class	Rated Voltage	Frame
PSM-20B	50/5A-200/5A		1.5-3	1.0	660V	5
PSM-20	50/5A-200/5A	20×10mm	1.5-3	1.0	660V	5
PSM-30	50/5A-200/5A	20×10mm	1.5-3	1.0	660V	5
PS-30	50/5A-300/5A	30×10mm	2.5-5	1.0	660V	5
PS-40	150/5A-800/5A	40×10mm	5-10	1.0	660V	5
PS-60	400/5A-1000/5A	60×10mm	10	1.0	660V	5
PS-100	800/5A-3000/5A	100×10mm	15	1.0	660V	5

**DIMENSION OF CASE[MM]:**

Model	A	B	C	D	E
PS-20A	56	30	63		80
PS-20	56	30	63		50
PS-30	56	30	63		50
PS-30	79	42	87		61
PS-40	79	42	87		61
PS-60	103	42	113		66
PS-100	151	42	166		61

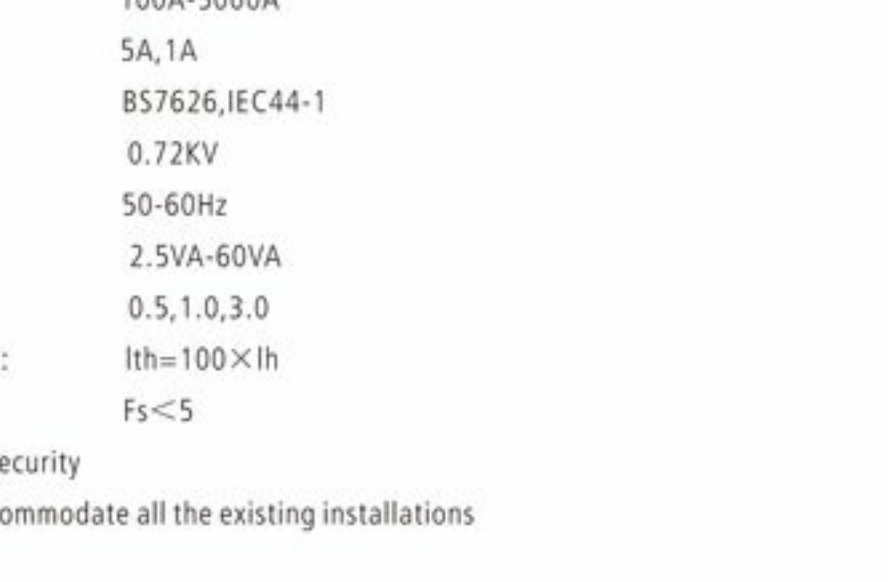
**OUTLINE DRAWING:****CPS CURRENT TRANSFORMERS****CPS SERIES:**

Primary current: 100A-5000A  
 Secondary approval: 5A, 1A  
 Standard approval: BS7626, IEC44-1  
 Maximum voltage: 0.72KV  
 Frequency: 50-60Hz  
 Rated load: 2.5VA-60VA  
 Class: 0.5, 1.0, 3.0  
 Short-time thermal current:  $I_{th}=100 \times I_h$   
 Rated security coefficient:  $F_s < 5$   
 -High fire retardancy and security  
 -Wide range of sizes to accommodate all the existing installations

**SPECIFICATION:**

Model	Primary/secondary(A)
CPS-40	100/5, 150/5, 200/5, 250/5, 300/5, 400/5, 500/5, 600/5A
CPS-60	300/5, 400/5, 500/5, 600/5, 800/5, 1000/5, 1200/5, 1500/5, 1600/5A
CPS-80	500/5, 600/5, 750/5, 800/5, 1000/5, 1200/5, 1500/5, 1600/5A
CPS-100	600/5, 750/5, 800/5, 1000/5, 1200/5, 1500/5, 1600/5, 2000/5, 2500/5, 3000/5A
CPS-120	1000/5, 1200/5, 1500/5, 1600/5, 2000/5, 2500/5, 3000/5, 4000/5A, 5000/5

**DIMENSION OF CASE[MM]:**

Dimensions	Dimensions			Busbar hole dimension		Installation dimension
	W	H	D	A	E	M
CPS-40	75	105	45	42	32	45
CPS-60	98	116	45	62	32	42
CPS-80	118	120	45	82	32	60
CPS-100	140	130	49	102	32	80
CPS-120	165	152	49	102	53	80

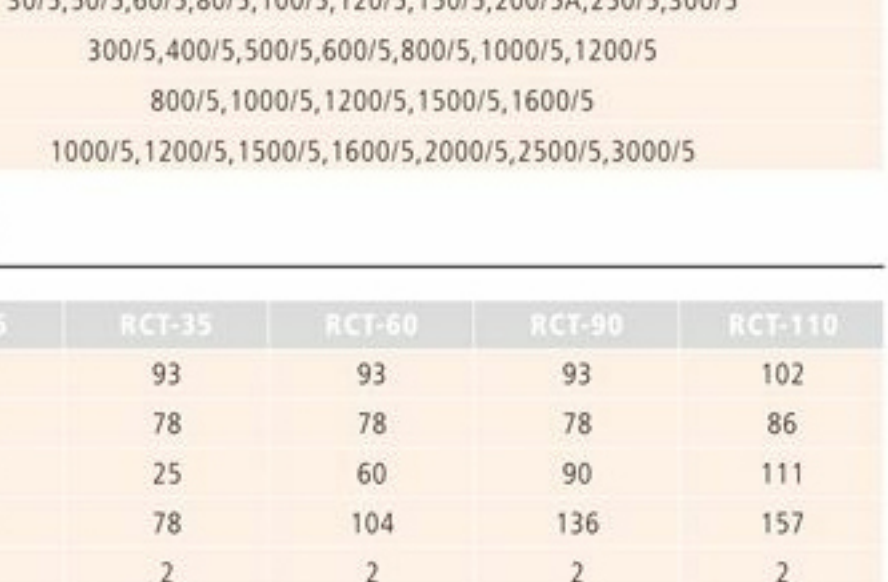
**OUTLINE DRAWING:**

Switch on to the future

**RCT CURRENT TRANSFORMERS****RCT SERIES:**

Primary current: 30A-3000A  
 Secondary current: 5A, 1A  
 Standard approval: IEC44-1  
 Maximum voltage: 0.66KV  
 Frequency: 50-60Hz  
 Rated load: 15VA  
 Class: 1.0  
 Short-time thermal current:  $I_{th}=60 \times I_h$   
 Rated security efficient:  $F_s < 5$

**SPECIFICATION:**

Model	Primary/secondary(A)
RCT-25	15/5, 200/5, 30/5, 40/5, 50/5, 60/5, 75/5, 100/5A
RCT-35	30/5, 50/5, 60/5, 80/5, 100/5, 120/5, 150/5, 200/5A, 250/5, 300/5
RCT-60	300/5, 400/5, 500/5, 600/5, 800/5, 1000/5, 1200/5
RCT-90	800/5, 1000/5, 1200/5, 1500/5, 1600/5
RCT-110	1000/5, 1200/5, 1500/5, 1600/5, 2000/5, 2500/5, 3000/5

**DIMENSIONS[MM]:**

Model	RCT-25	RCT-35	RCT-60	RCT-90	RCT-110
A	93	93	93	93	102
B	78	78	78	78	86
C	25	25	60	90	111
D	78	78	104	136	157
E	2	2	2	2	2
F	55	55	41	41	52
G	9	9	9	9	9

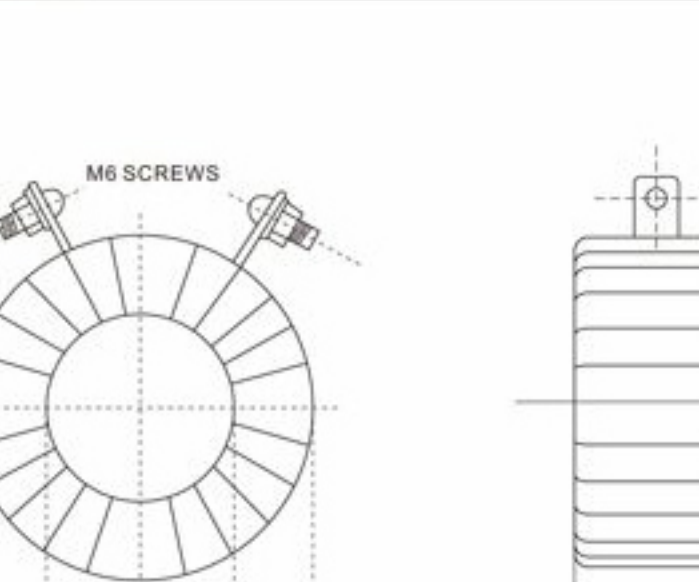
**OUTLINE DRAWING:****MR CURRENT TRANSFORMERS****MR SERIES:**

Primary current: 30A-5000A  
 Secondary current: 5A, 1A  
 Standard approval: BS7626, IEC185  
 Maximum voltage: 0.72KV  
 Frequency: 50-60Hz  
 Rated load: 5VA-15VA  
 Class: 1.0, 3.0  
 Short-time thermal current:  $I_{th}=60 \times I_h$   
 Rated security efficient:  $F_s < 5$

**SPECIFICATION & DIMENSIONS[MM]**

Model	Specification	ID	CD	HT
MR-28	30/5A-60/5A	28	70	40
MR-42	100/5A-250/5A	42	80	30
MR-45L	300/5A	45	80	30
MR-60L	400/5A	60	100	30
MR-60	500/5A-600/5A	60	100	30
MR-85L	800/5A-1600/5A	85	120	20
MR-125L	2000/A-5000/5	125	165	20

Noted: For measuring current transformers, the accuracy class is designated by the highest permissible percentage current (ratio) error at the rated current prescribed for the accuracy class concerned.

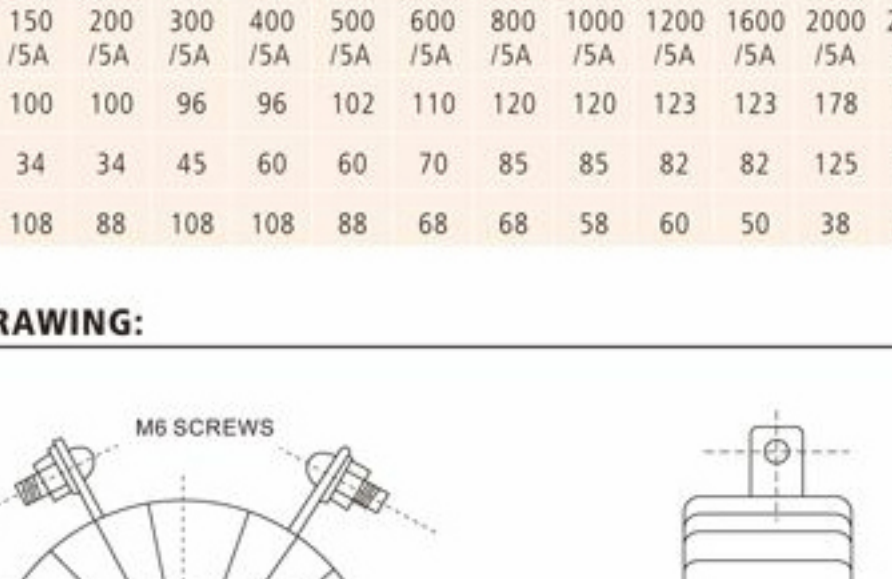
**OUTLINE DRAWING:**

Switch on to the future

**PR CURRENT TRANSFORMERS**

Protective current transformers are required to operate over a range of current many times the circuit rating and is frequently subjected to conditions greatly exceeding those which it would be subjected to as a measuring current transformer. When a current transformer is used to energise a protective relay, it must maintain its characteristic ratio up to some multiple of its rated current. This multiple, may be 5, 10, 20 or some even higher value and is known as "Accuracy Limit Factor" (ALF). Therefore, the selection of Protective Current Transformers in relation to accuracy class and ALF require a close examination of relay characteristic and circuit conditions which includes the relay burden and the pilot wire lead burden.

**DIMENSIONS[MM]:**

Spec.	100/5A	150/5A	200/5A	250/5A	300/5A	400/5A	500/5A	600/5A	CI:10P5 15VA
OD	60	100	100	100	96	100	100	100	
ID	34	34	34	34	34	60	60	65	
HT	148	98	68	58	68	68	68	58	

Spec.	100/5A	150/5A	200/5A	250/5A	300/5A	400/5A	500/5A	600/5A	CI:10P10 15VA
OD	100	100	100	100	120	120	123	123	
ID	34	34	34	34	34	60	60	65	
HT	180	130	110	110	90	110	88	88	

Spec.	100/5A	150/5A	200/5A	250/5A	300/5A	400/5A	500/5A	600/5A	CI:10P10 15VA
OD	100	100	100	100	120	120	123	123	
ID	34	34	34	34	60	60	70	85	
HT	168	108	88	108	108	88	68	68	

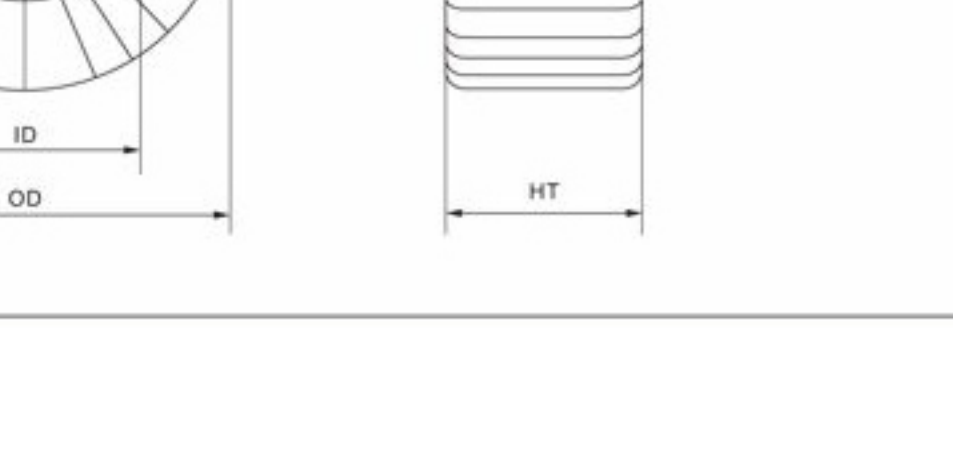
**OUTLINE DRAWING:****MR CURRENT TRANSFORMERS**

Model	Specification	ID	CD	HT
MR-28L	30/5A-60/5A	28	70	40
MR-42L	100/5A-250/5A	42	80	30
MR-45L	300/5A	45	80	30
MR-60L	400/5A	60	100	30
MR-60L	500/5A-600/5A	60	100	30
MR-85L	800/5A-1600/5A	85	120	20
MR-125L	2000/A-5000/5	125	165	20

Noted: For measuring current transformers, the accuracy class is designated by the highest permissible percentage current (ratio) error at the rated current prescribed for the accuracy class concerned.

**OUTLINE DRAWING:**